

Article number: 203160M16150C3V

Description: E+G levelling foot
GN 31-60-M16-150-C3-V

Note: V Without nut, External hexagon at the top, Wrench flat at the bottom

Measures

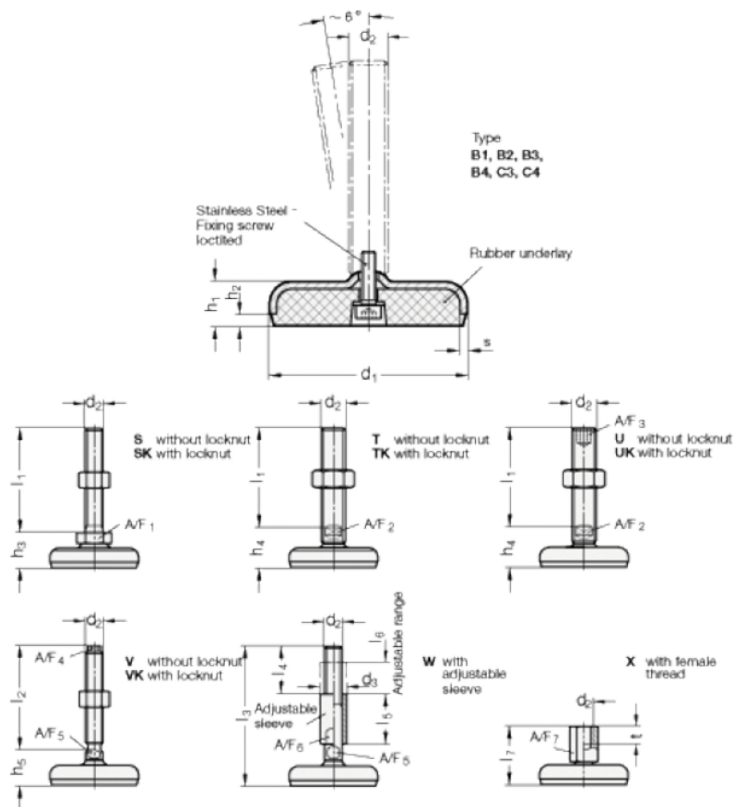

A/F4	= 10	s = 3
A/F5	= 12	
d1	= 60	
d2	= 16	
h1	= 16	
h2	= 4	
h5 +4.0/0	= 27	
l2	= 150	